

SCX900HD-2

HYDRAULIC CRAWLER CRANE

Specifications



SCX900HD-2

Superstructure

UPPER REVOLVING FRAME:

All-welded, precision machined, robust construction. A machined surface provided for mounting load hoist, opt. 3rd drum and boom hoist assemblies, and mounting itself on turntable bearing.

TURNTABLE BEARING WITH INTERNAL SWING GEAR:

Single shear ball type; inner race of turntable bearing with integral, internal slewing (ring) gear bolted to lower frame, and outer race of turntable bearing bolted to upper revolving frame.

CONTROL SYSTEM:

System contains one set each of quadruplicate and triplicate tandem valves which direct oil to various machine function and are actuated by control levers via remote controlled hydraulic servo for all motions. Working speeds can be precisely controlled by pilot-operated armchair single axis control levers in cooperation with "EPC" controller that varies engine rpm and hyd. pump discharge simultaneously, or varies just hyd. pump discharge while keeping engine rpm via motorcycle type grip throttle. System also takes a specially-tailored unique hydraulic circuits to maximizes drum horsepower, and reduces horsepower loss with eliminating the possibility of engine stall.

Pump control system — By "EPC" controller that provides two modes of engine-pump control.

MODE I:

The "EPC" controller is normally programmed to vary the engine speed and pump discharge simultaneously. Simply twisting the grip advances the engine to maximum speed and the hydraulic pumps to maximum flow at the same time. This mode is suitable to precision crane work.

MODE II:

By activating a switch, it is able to vary just the pump discharge by means of the grip throttle, while keeping engine speed fixed. Mode II is convenient for duty cycle works such as clamshell operation, where the engine is normally run at full throttle.

A specially-tailored pressure compensating valve —

Utilized in hydraulic circuits to realize a good minute operation of two main, boom hoist and opt. 3rd drums.

HYDRAULIC SYSTEM:

System provided with three variable displacement axial piston pumps for both independent and combined operations of all functions, and four fixed displacement gear pumps for system valve and cylinder controls.

Main/aux. crane hoist motors — Variable displacement axial piston motor with counterbalance valve.

Boom hoist motor — Axial piston type with counterbalance valve and spring-applied/power hydraulically released multiple wet-disc type automatic brake.

Third drum motor — Optional extra; variable displacement axial piston motor with counterbalance valve as same as that of main/aux. winches.

Slewing motor — Two; axial piston type with spring-applied/power hydraulically released multiple wet-disc type brake.

Travel motors — Shoe-in design; variable displacement axial piston motor with brake valve and spring-applied/power hydraulically released multiple wet-disc type automatic brake.

Oil cooler — Aluminum-make; available for not only a good rustproof but also high cooling efficiency.

Hydraulic oil reservoir — 450 liters capacity.

LOAD HOIST ASSEMBLY:

Front and rear main operating drums driven by independent hydraulic motor of bi-directional, variable displacement axial piston motor through a 2-stage planetary reduction gear unit powering the rope drum in either direction for hoisting and lowering load. Reduction gear unit installed within drum inside together with multiple wet-disc brake unit. Drum each sized in same dimension.

Brakes — Multiple wet-disc unit with negative brake design that takes the function of "spring-applied, power hydraulically released", and maintains a high brake safety even if a hydraulic pressure drop in the circuit happens; installed within drum inside together with shaft-coupled reduction gear unit. Eliminate clutch, and require no brake maintenance on this brake design.

Brake control — Applies dynamic hydraulic pressure for brake release operation with an extreme light pedaling force.

Brake mode — Available in two modes; one is automatic as suitable for liftcrane operation, and the other is free-fall mode as suitable for bucket operation. Free-fall interlocking is also designed for fail-safe operation.

A forced-oil cooling system — Available in both front and rear drum brake units to keep brake performance even in continuous heavy-duty operations.

Drum rotation sensors — Fitted on top of control levers. Available to let operator sense a drum rotation speed decrease when the load is just lifted off ground.

Drum rotation speed controller — Max. rotation speed can be tuned according to arbitrary value that is electrically controlled by dialing, and then varies pump discharge. Available on two main operating drums independently.

Motor swash plate angle setting switch — Available to set motor swash plates of front/rear drum winch motors at a certain angle for easily synchronizing front and rear drum rotation speeds as good for clamshell /diaphragm wall bucket applications.

Drums — One piece, parallel grooved lagging with locking ratchet wheel cast integral; bolted to reduction gear unit. Available to wind up 41m long cable of 28mm dia. at drum 1st layer.

Drum locks — Electrically operated pawl.

Drum rollers — Optional extra; available for right cable winding onto drums.

BOOM HOIST ASSEMBLY:

Driven by bi-directional, axial piston hydraulic motor through 2-stage planetary reduction gear unit powering the rope drum in either direction for hoisting and lowering boom.

Brake — Spring-applied, power hydraulically released multiple wet-disc type automatic brake.

Drum rotation sensor — Fitted on top of control lever. Available to let operator sense a drum rotation speed decrease when the load is just applied.

Drum rotation speed controller — Max. rotation speed can be tuned according to arbitrary value that is electrically controlled by dialing, and then varies pump discharge.

Drum — One piece, parallel grooved lagging with locking ratchet wheel cast integral; bolted to reduction gear unit.

Drum lock — Power hydraulically operated pawl with automatic locking device.

THIRD HOISTING MECHANISM:

Optional extra; available in almost same design as that of front and rear main operating winches except drum lagging flange diameter.

Brake — Multiple wet-disc unit with negative brake design as same as that of front/rear main operating winches.

Brake control — Applies dynamic hydraulic pressure for brake release operation as same as that of front/rear main operating winches.

Brake mode — Available in two modes of automatic and free-fall as same as that of front/rear main operating winches. Free-fall interlocking is also designed for fail-safe operation.

A forced-oil cooling system — Available to keep brake performance as same as that of front/rear main operating winches.

Drum — One piece, parallel grooved lagging as same as that of front/rear main operating winches, except drum lagging flange diameter.

Drum lock — Electrically operated pawl.

SLEWING:

Driven by two units of bi-directional, axial piston hydraulic motors through 2-stage planetary reduction gear unit powering slewing pinion. Slewing pinion meshes with internal teeth of slewing (ring) gear of turntable bearing inner race.

Brakes — Spring-applied, power hydraulically released multiple wet-disc type; provided on each of hydraulic motor.

Slewing speed control — Max. slewing speed can be tuned according to arbitrary value that is electrically controlled by dialing, and then varies pump discharge.

Lock — Mechanically operated drop pin.

Speed — 2.5min^{-1} < 2.5rpm >.

GANTRY:

A-frame type; raised and lowered by power hydraulic cylinders.

OPERATOR'S CAB:

A 2.3mm thickness steel plate construction with 940mm wide and a stamped-and-rounded corner designs; acoustically treated, full-vision, cushion rubber mounted, well-ventilated, full compartment, roomy operator's cab with a large straighted front window with green-tinted safety glass; provided with an arrangement of "EPC" control/slewing lever, armchair control station, sunvisor, sunshade, rear-view mirrors, dual intermittent type window shield wipers with washer on both front and roof windows, sliding windows on both sides of cab, and swing-link type sliding door.

Instrument panel — Contains engine monitoring lamps, graphic display panel of Load Moment Indicator, gauges & meter, warning lamps and other necessary controllers and switches.

Operator's seat — Full adjustable reclining seat with head rest and both R/H and L/H side arm rests.

Anemometer — Analogue type. Indicates wind velocity and alarms when the velocity exceeds a figure set.

Air-conditioner — Built-in type full air-conditioner.

Engine foot throttle — Optional extra; available for right-hand foot with electrical control.

Electric outlet — 24V; available in cab.

Microphone & loud-speaker — Optional extra; this is for operator's convenience for loud speaking.

Operator's cab sidestep — Available for access ease to operator's cab.

AM/FM radio — Provided as std. with clock.

Fire extinguisher — Optional extra; powder type with 1kg capacity.

MACHINERY CAB:

Equipped with hinged doors on both sides for machinery access and inspection; affixed with tape-type non-skid material on the roof.

CATWALKS:

Optional extra; hitched in place along both sides of machinery cab.

HYDRAULIC TAGLINE:

Optional extra; available for clamshell application. Provided in front of upper revolving frame for preventing a shake of suspended load by a 10mm dia. tug cable with light force.

COUNTERWEIGHTS:

Weighs 29.7ton with a 3-cast iron block, removable, corner-rounded design. Three blocks consist of "A" (9,900kg), "B" (9,900kg) and "C" (9,900kg).

AUXILIARY WEIGHT:

Weighs 2.0ton. Mounted on part of optional 3rd drum location; if 3rd drum is optionally required, this aux. weight is not required.

ELECTRICAL SYSTEM:

24-volt negative ground system; provided with two maintenance free batteries of 12V×150AH.

LIGHTING SYSTEM:

Includes following lights.

- Two working lights;
- One interior cab light.

REAR VIEW MIRRORS:

Two; provided on front-left and -right corners of super-structure.

SHAFTS AND PINS:

Most of shafts and pins used on superstructure are with zinc or nickel or chromium plating for rustproof except A-frame gantry peak shaft.

POWER UNIT:

Make & Model	Mitsubishi 6M70-TL
Type	Water-cooled, 4-cycle, direct injection, turbo-charged, diesel
No. of Cylinders	Six (6)
Bore & Stroke	130 mm × 150 mm
Displacement	12,880 cc
Rated Output	272 kW/2,000 min ⁻¹ < 370 ps/2,000 rpm >
Maximum Torque	1,510 N·m/1,600 min ⁻¹ < 154 kgf-m/1,600 rpm >
Fuel Tank	450 liters

Note:

1. The engine meets Stage/Tier 3 of current smoke emission regulations in Europe, America and Japan.
2. A 272kW engine horsepower shown above is defined under a current international engine horsepower indication formula which includes necessary horsepower for engine alternator drive but excludes engine fan drive.

Undercarriage

LOWER FRAME:

All-welded, precision machined, box type construction; provided with longer axle with folding type tips reaching up to axle box end of crawler side frame for better fitting between axle and crawler side frames. A machined surface provided for mounting turntable bearing.

LOWER FRAME JACK-UP DEVICE:

Contains four hydraulic jack cylinders with cylinder beams pinned to lower frame for extending/retracting, and disassembling/assembling ease of crawler side frames.

Remote control box — Provided for controls of both lower frame jack and crawler side frame removal cylinders.

Pontoon — All-welded construction; four pontoons each stored at an inside part of jack cylinder beams.

CRAWLER SIDE FRAMES:

All-welded, box type construction, precision machined; positioned on lower frame axle beam, and held in place by beam-end pins.

Safety Devices

Retract unit — Independently available on right-and left-hand crawler side frames for individually extending/retracting, and assisting in removing side frames. Controlled from not only operator's cab, but also, remote control box as available.

Crawler side steps — Provided at both ends of the frames for easy access to superstructure.

DRIVE SPROCKETS:

Cast steel, heat treated; one per side frame. Track drive sprocket assembly bolt-coupled to 2-stage planetary reduction gear unit outer case as an integral part of shoe-in type traction motor. Sealed between parts of rotation and non-rotation of the motor with floating seal.

IDLER WHEELS:

Cast steel, heat treated; one per side frame. Mounted on two bronze bushings with floating seals for lifetime lubrication.

TRACK ROLLERS:

Ten per side frame; each heat treated cast steel with double flange design. All mounted on two bronze bushings with floating seals for lifetime lubrication.

CARRIER ROLLERS:

Two per side frame; each heat treated cast steel with double flange design. All mounted on two bronze bushings with floating seals for lifetime lubrication.

TRACKS:

Heat treated, self-cleaning, multiple hinged track shoes joined by full floating pins; 53 pcs. per side frame.

Shoe width — 810mm wide.

Track adjustment — Manual adjustment with oil jack and shim plate packs is standardized.

Automatic track tension adjusting device — Optional extra; available instead of std. track adjustment to always keep track tension at optimum level by means of power hyd. cylinder thru idler wheel actuated by power hydraulic supplied from superstructure.

TRAVEL AND STEERING:

A bi-directional, shoe-in type axial piston hydraulic motor bolt-couples with drive sprocket thru 2-stage planetary reduction gear unit outer case at each crawler side frame end for travel and steer. Straight-line travel (forward or reverse), pivot or differential turns, and counter-rotation for spin turns available.

Brake — Spring-applied, power hydraulically released multiple wet-disc type automatic brake; located within hydraulic motor. Brakes automatically set when travel levers are in neutral or when engine is shut down.

Travel speed — Two stages; 2.1/1.2km/hr. (based on flat, level and firm supporting surface, and under the conditions that no load must be applied and front-end att. must be the 12.0m basic boom only).

Gradeability — 30% (17°) permissible based on basic machine without front-end attachment.

LOAD MOMENT INDICATOR:

This is a fully computerized automatic over-load preventing system including total safe operation control system; provided with the designs of (1) no zero-point adjustment, (2) data input according to interface counter-indication/message on display panel, and (3) a graphic display panel with setting ease of viewing angle.

Construction (standard version) — Comprises (1) load detecting device with amplifier, (2) boom angle detector, (3) computerized Micro Processing Unit (M.P.U.), and (4) graphic display panel.

Functions — This system functions that if the lifting load reaches 90% of the rated one specified in the crane capacity chart, an intermittent pre-warning buzzer is given; if it is 100%, a warning is given by a continuous buzzer, and all peril side motions are automatically stopped. The machine, however, can be operated in safety side motions.

Display panel design — A graphic display panel is designed, and it is able to input necessary operating conditions/data according to interface counter-indication/message on the display panel, and the display panel indicates ten and some kinds of the present lifting and working conditions/data like "lifting load", "max. allowable lifting load", "working radius", "max. allowable working radius", "boom angle", "load ratio", "boom/jib lengths", "engine rpm" and so on when working. In addition, the display panel is provided with three warning indicators over "engine over-heat", "hyd. oil over-temp." and "brake oil over-temp.".

MAIN HOOK OVER-HOISTING LIMITER:

Limit switch type. Available to prevent hook over-hoisting with functions of automatic drum braking with hydraulic lock, and warning by buzzer.

BOOM OVER-HOISTING AND -LOWERING LIMITER:

Available in two kinds of devices; one is limit switch located on a part of boom foot for preventing boom over-hoisting, and the other is the safety function of the LMI available to automatically prevent boom over-hoisting and-lowering with the functions of automatic drum braking with hydraulic lock, and warning by buzzer. Further boom protection from rapid boom over-hoist by hook over-hoist motion under mal-function of hook over-hoist limiting device is available as one of functions of the LMI.

BOOM BACKSTOPS:

Dual; telescopic design with spring buffers.

SECONDARY BOOM OVER HOISTING LIMITER:

Additional limit switch located on boom backstops; this is as a further safety device for redundant boom protection.

SLEWING LOCK:

Mechanically operated drop pin; available to firmly lock superstructure in four positions of facing front or rear or left or right to undercarriage.

DRUM LOCKS:

Electrically operated pawl locks is available on front and rear main drums while power hydraulically operated pawl lock is available on boom hoist drum with an automatic locking device as std.

THIRD DRUM LOCK:

Provided as std. when an optional 3rd drum winch is provided.

FREE-FALL INTERLOCKING:

Available on both front and rear main drum brake lines for fail-safe operation. Functions that free-fall brake mode is only available when drum brake pedal is pressed even though brake mode is switched on free-fall mode.

SLEWING BRAKE SAFETY CIRCUIT:

Available not to start engine whenever slewing brake is off.

ENGINE START INTERLOCK SYSTEM:

Available not to start engine whenever drum brake mode is in "free-fall".

BOOM ANGLE INDICATOR:

Pendulum type; mounted on right-hand side of bottom section of crane main boom.

HOOK LATCH:

Provided on every kinds of hook to prevent out of place of cable from hook.

LEVEL GAUGE:

Bubble type; located on operator's cab floor of superstructure.

INDEPENDENT LEVER LOCKS:

Provided on all control levers (except slewing lever) to lock levers in neutral.

SLEWING ALARM:

This is by buzzer, and flasher lamps located on both sides of machinery cab.

TRAVEL ALARM:

Available by an intermittent buzzer.

SPEED SLOWDOWN DEVICE:

This is for speed slowdown of hoisting and lowering motions of boom which are available just before automatic stopping at both upper and lower side limits of boom angle even though control lever(s) is still at hoisting/lowering position to prevent a shock.

SLEWING BRAKE LAMP:

Provided on operator's cab instrument panel; this is available to confirm whether or not slewing brake is applied.

SIGNAL HORN:

Available as warning just before every kinds of motions are initiated.

LOCK LEVER (FOOL PROOF SHUT-OFF LEVER):

Located in the cab exit; this is available to automatically deactivate and lock hydraulic system.

FRONT-END ATT. ERECTION MODE:

This is an internal, integral function of the LMI. In the range out of crane working area, the LMI display panel automatically indicates "Now, out of crane working range" with a rigging instruction, and it is available to lift front-end att. off ground without the influence of LMI safety functions, and, after front-end att. is lifted over the range of crane working area, LMI safety fuction gets back automatically for safe erection work. This function is also available for the work of vice-versa.

LMI SAFETY CIRCUIT-OFF SWITCH:

Available in key type for a good crane safety operation management without fail.

TRAVEL DIRECTION ARROW:

Attached each on crawler side frames.

GAUGES & METER:

Engine water temperature gauge, fuel gauge and hour-meter are provided on instrument panel.

WARNING LAMPS:

Available to let operator warn abnormal machine conditions as to pilot pressure and brake system of two main and opt. 3rd drums.; provided on instrument panel.

ENGINE MONITORING LAMPS:

Available to let operator warn engine abnormal conditions as to battery charge, lubrication oil pressure, radiator coolant level, oil filter clogging, air filter clogging, water temp., control unit and glow plug.; provided on instrument panel.

EMERGENCY ENGINE STOP SWITCH:

Located at cab instrument panel, and available to stop engine whenever it is necessary.

THREE COLOR PERCENTAGE INDICATOR:

Optional extra; this is with three colors of Green, Yellow and Red. Each color indicates the load percentage to rated capacity; Green shows less than 90% as safety, Yellow shows 90 to 99% as marginal, and Red shows over 100% as over-loading. As further function, Red lamp comes on automatically when operator cuts off safety circuit of the LMI absent-mindedly.

DRUM LIGHT & MIRROR:

Optional extra; these are available for checking rope winding onto front and/or rear drum(s).

AUX. CRANE HOOK OVER-HOISTING LIMITER:

Optional extra; this is available for auxiliary crane hoist with optional short jib. Performs the same function as that of "Hook over-hoisting limiter" mentioned before.

LIFTING HEIGHT INDICATION DEVICE:

Available to indicate lifting height above ground or depth below ground on display panel of the LMI. Also, hook hoisting speed slowdown function is available just before automatic stopping at a desired height under hook height setting before operation.

Front-end Attachment

BOOM:

Lattice construction, round tubular main chords, alloy, hi-ten steel, with bracing of round steel tubing.
Boom connections..... In-line pin connections at 1.55m deep and 1.55m wide.
Basic boom..... Two-piece, 12.0m basic length; 6.0m base and tapered top sections.
Boom head machinery..... Four head sheaves and two guide sheaves with rigid type rope guard.
Sheaves all mounted on anti-friction bearings of conventional, non sealed-grease type.
Boom extensions..... Optional extra; available in 3.0m, 6.0m and 9.0m lengths with pendants.
Maximum boom length..... 60.0m for liftcrane application.
24.0m for clamshell application.

SHORT JIB:

Optional extra; all-welded construction having single sheave head machinery. Pinned to 6.0m tapered crane top section. Available for 13.5ton lift as maximum with single part hoist line.

HOOK BLOCKS:

Sheaves all mounded on anti-friction bearings. Available in 4 kinds of capacities as under:
90t, four sheaves with duplex type hook..... Optional extra.
50t, three sheaves..... Optional extra.
35t, one sheave..... Optional extra.
13.5t, ball hook..... Optional extra.

BAIL AND BRIDLE:

All-welded construction; provided with larger sheaves of a 21.0 D/d ratio on both bail and bridle for 10-part boom hoist rope reeving. Bail pinned to A-frame gantry, and bridle suspended between a 10-part boom hoist rope and pendant ropes connecting to tip of 6.0m tapered crane top section. Sheave all mounted on anti-friction bearings of conventional, non sealed-grease type.

DRUM DATA:

Drum	Root dia.	Type	Line speed (Hoisting, Lowering)	Cable	Max. line pull
Front (main crane hoist)	596mm	Parallel grooved	110 ~ 2mpm	28mm	245kN <25t>
Rear (aux. crane hoist)	596mm	Parallel grooved	110 ~ 2mpm	28mm	245kN <25t>
Boom hoist	463.6mm	Parallel grooved	46 ~ 2mpm	22.4mm	152kN <15.5t>
Optional 3rd	596mm	Parallel grooved	73 ~ 2mpm	26mm	196kN <20t>

Notes:

1. Line speed is based on drum first layer and rated engine rpm.
2. Hoisting line speed varies under load and operating conditions.

HOIST REEVING:

(t)

Kind of hook block \ No. of partline	8	7	6	5	4	3	2	1
90t	90.0	87.5	75.0	62.5	50.0	—	—	—
50t	—	—	—	—	50.0	37.5	25.0	—
35t	—	—	—	—	—	35.0	25.0	—
13.5t	—	—	—	—	—	—	—	13.5

CABLES:

- Front drum..... 3×F (a+40), non-spin type, 28mm dia./200m long, breaking load 680kN <69.3t>.
 Rear drum..... Optional extra; 3×F (a+40), non-spin type, 28mm dia./170m long, breaking load 680kN<69.3t>.
 Boom hoist drum IWRC 6×P·WS (31), 22.4mm dia./150m long, breaking load 367kN <37.4t>.
 Optional 3rd drum Optional extra; 3×F (a+40), non-spin type, 26mm dia., breaking load 569kN <58.0>. Length depends on request.

Liftcrane 90 metric tons

■ LIFTCRANE CAPACITIES:

Boom length (m) Working radius (m)	12.0	15.0	18.0	21.0	24.0	27.0	30.0	33.0	36.0	39.0	42.0	45.0	48.0	51.0	54.0	57.0	60.0
4.0	90.00																
4.5	80.50	77.00															
5.0	70.80	69.20	66.00/5.1														
5.5	62.40	61.60	60.60	58.70/5.6													
6.0	55.00	55.00	55.00	54.90	52.90/6.2												
6.5	48.80	48.80	48.80	48.75	48.65	44.00/6.7											
7.0	44.00	44.00	44.00	44.00	43.80	43.70	41.25/7.3	37.25/7.8									
8.0	36.40	36.40	36.30	36.20	36.10	36.10	36.00	35.80	30.00/8.4	30.00/8.9							
9.0	30.90	30.80	30.70	30.60	30.50	30.40	30.30	30.10	30.00	29.50	28.20/9.4						
10.0	26.70	26.60	26.50	26.40	26.30	26.20	26.10	25.90	25.80	25.70	25.70	25.50	22.00/10.5	22.00/11.1	20.05/11.6		
12.0	21.50/11.8	20.80	20.60	20.50	20.40	20.40	20.20	20.00	19.90	19.80	19.70	19.60	19.60	19.40	19.30	17.95/12.2	15.00/12.7
14.0		16.90	16.80	16.70	16.50	16.50	16.30	16.10	16.00	15.90	15.80	15.70	15.60	15.50	15.30	15.20	14.50
16.0		16.30/14.4	14.20	14.00	13.90	13.70	13.50	13.40	13.30	13.10	13.00	12.90	12.80	12.60	12.50	12.40	12.20
18.0			13.05/17.0	12.00	11.90	11.70	11.50	11.40	11.30	11.10	11.00	10.90	10.80	10.70	10.60	10.50	10.10
20.0				10.85/19.6	10.30	10.20	10.00	9.80	9.70	9.60	9.40	9.30	9.20	9.10	9.00	8.80	8.60
22.0					9.00	8.90	8.70	8.60	8.50	8.30	8.20	8.00	7.90	7.80	7.60	7.50	7.30
24.0					8.85/22.2	7.90	7.70	7.60	7.50	7.30	7.10	7.00	6.90	6.80	6.60	6.40	6.30
26.0						7.45/24.8	6.90	6.70	6.60	6.40	6.30	6.10	6.00	5.90	5.80	5.60	5.40
28.0							6.40/27.4	6.00	5.90	5.70	5.60	5.40	5.30	5.20	5.00	4.80	4.60
30.0								5.40	5.30	5.10	4.90	4.80	4.70	4.50	4.30	4.10	3.90
32.0									4.80	4.60	4.40	4.20	4.10	3.90	3.70	3.50	3.20
34.0									4.65/32.6	4.10	3.90	3.70	3.60	3.40	3.20	2.90	2.70
36.0										3.85/35.2	3.50	3.30	3.10	2.90	2.70	2.50	2.30
38.0											3.15/37.8	2.90	2.70	2.50	2.30	2.10	1.80
40.0												2.55	2.30	2.10	1.90	1.70	1.50
42.0												2.50/40.4	2.00	1.80	1.60	1.50/41.0	
44.0													1.85/43.0	1.55	1.50/42.7		
46.0														1.50/44.4			

■ WORKING MASS & GROUND CONTACT PRESSURE:

Shoe width	Mass	Pressure
810mm	85.0t	96.0kPa <0.98kg/cm²>

Note: Working mass shown above is with 12.0m basic boom, 29.7ton counterweight, 2.0ton auxiliary weight and optional 90t hook block.

Notes — Liftcrane capacities

1. Capacities included in this chart are the maximum allowable, and are based on machine standing level on firm supporting surface under ideal job conditions.
2. Capacities are in metric tons, and are not more than 78% of minimum tipping loads except the figures surrounded by bold lines which are based on other factor of machine structural strength limitation; the design codes/standards applied to the capacities are from "Construction Codes for Mobile Crane" and "Ordinance on Safety of Crane and Similar Equipment" issued by Ministry of Health, Labour and Welfare, Japan.
3. Capacities are based on freely suspended loads and make no allowance for such factors as the effect of wind, sudden stopping of loads, supporting surface conditions, and operating speeds. Operator must reduce load ratings to take such conditions into account. Deduction from rated capacities must be made for mass of hook block, weighted ball/hook, sling, spreader bar, or other suspended gear.
Hook block mass is as follows:
90t 1.20ton 50t 0.95ton 35t 0.73ton
13.5t 0.62ton
4. All capacities are rated for 360° slewing.
5. Least stable rated condition is over the side.
6. A 29.7ton counterweight and 2.0ton aux. weight (or opt. 3rd drum) are required for all capacities on this chart.
7. Crawler side frame must be fully extended for all operating conditions.
8. Attachment must be erected and lowered over the ends of the crawler mounting.
9. Main boom length must not exceed 60.0m.
Maximum boom length when mounting short jib is 54.0m.
10. Capacities when handling load off main boom head sheaves in case of mounting short jib on top of boom are detailed; if required, please consult us or nearest distributor.

SCX900HD-2 SHORT JIB CAPACITIES:

Max. 13.5t

Note: Jib capacities is almost equal to the figures made by the deduction of a 620kg from the liftcrane capacities for boom length up to 54.0m unless restricted by the maximum jib capacity shown above. As to the details, please consult us or nearest distributor.

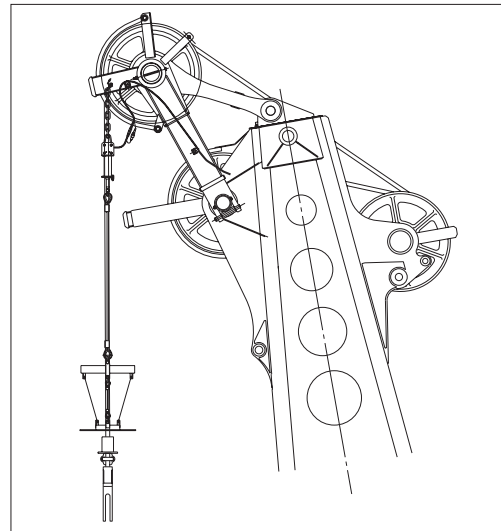

Short jib (Option)

Liftcrane Working Ranges

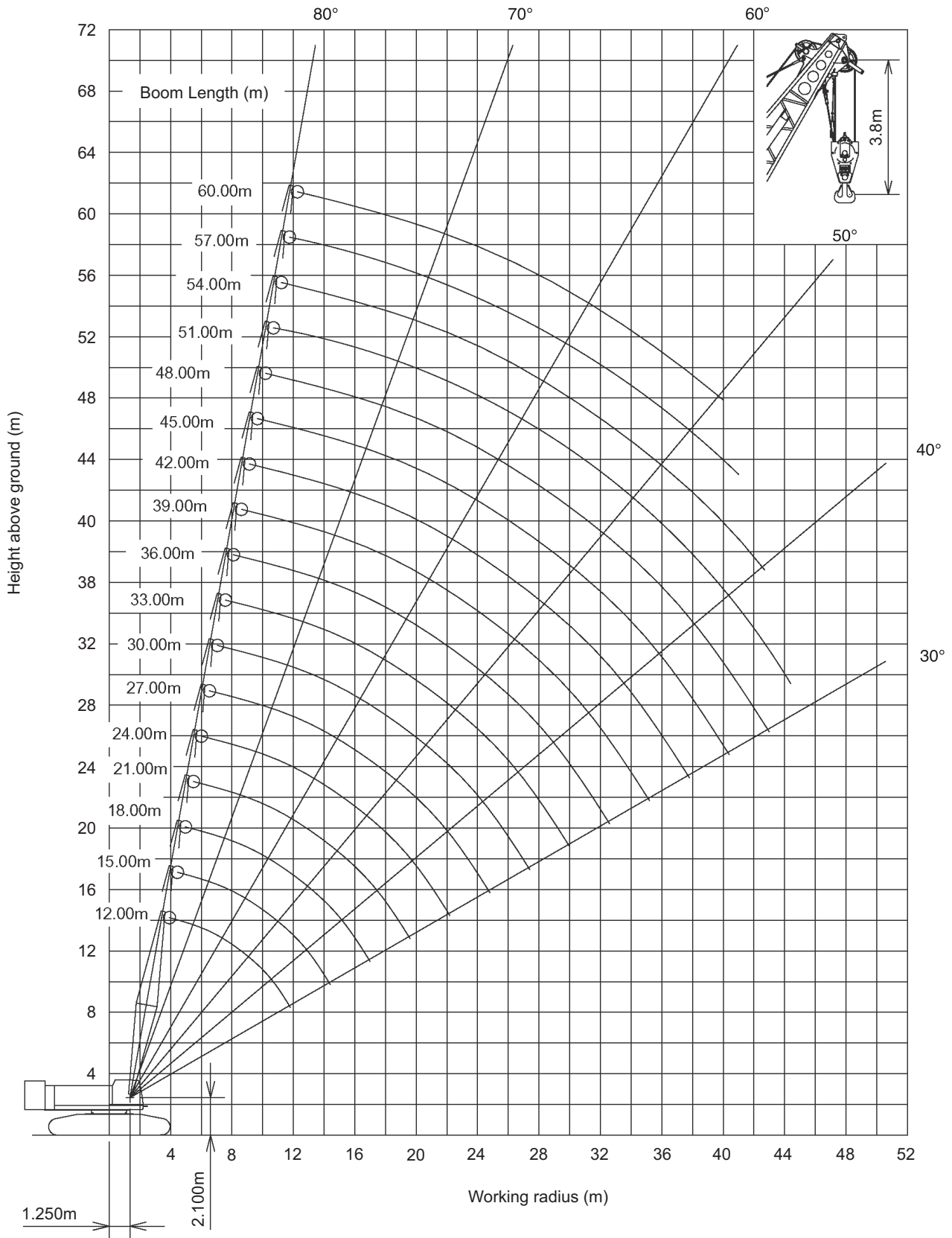

Notes :

The above diagram shows two kinds of locuses of boom peak sheave and hook points; the lower lines of boom indicate the locus of hook point, and the upper lines each show the locus of boom peak sheave point.

Clamshell 3.0m³ over

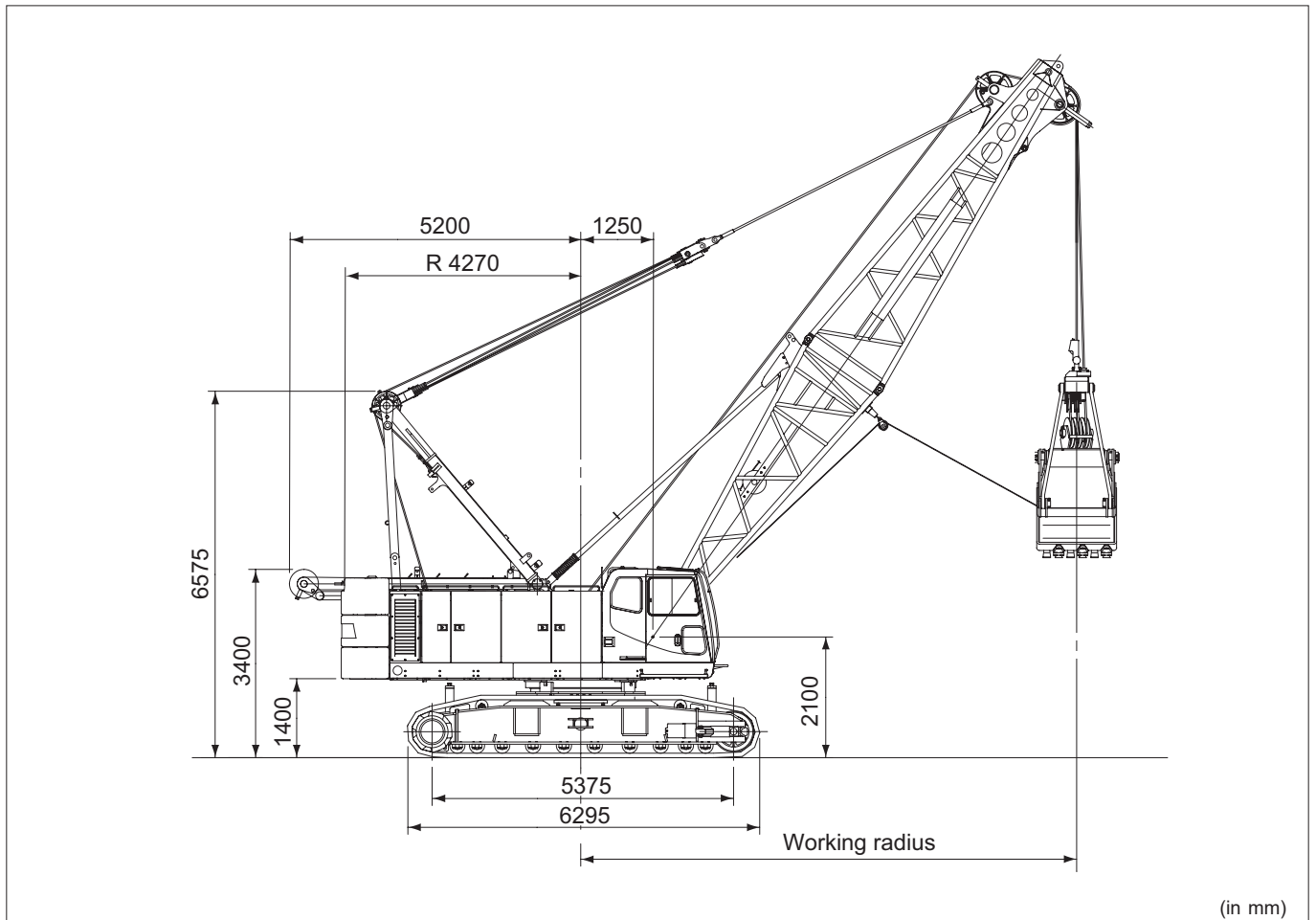

(in mm)

CLAMSHELL RATINGS:

(in metric tons)

Boom length (m) Working radius (m)	12.0	15.0	18.0	21.0	24.0
7.1	12.50	12.50/7.2			
8.0	12.50		12.50/8.2		
9.0	12.50	12.50		12.50/9.3	
10.0	12.50	12.50	12.50		12.50/10.3
12.0	12.50/11.6	12.50	12.50	12.50	12.50
14.0		12.50	12.50	12.50	12.50
16.0		12.50/14.1	12.50	12.30	12.20
18.0			11.90/16.5	10.50	10.40
20.0				10.00/19.0	9.00
22.0					
23.9					8.30/21.4

Notes:

- Max. clamshell rating is 12.5t.
- Mass of bucket plus load should not exceed clamshell ratings shown above. Following data are for a general digging application buckets.

Bucket capacity	3.0m ³
Bucket mass	6.5t
- Boom length shall not exceed 24.0m.
- Apparent specific gravity of lifting material:
 - Earth..... 1.7~1.8t/m³
 - Gravel..... 1.8~2.0t/m³
- High gantry is required and side frame must be fully extended for all operating conditions. Also, 29.7t counterweight and 2.0t aux. weight are required for all clamshell ratings shown above.
- Max. digging depth below ground shall be 36m.

WORKING MASS & GROUND CONTACT PRESSURE:

Shoe width	Mass	Pressure
810mm	89.0t	100kPa <1.02kg/cm ² >

Note: Working mass shown above is with 12.0m boom, 29.7ton counterweight, 2.0ton aux. weight, hydraulic tagline winder and 3.0m³/6.5t clamshell bucket.

BUCKET DIMENSIONS:

(in m)

		3.0m ³
A	Bucket overall height (opened)	4.55
B	Bucket overall height (closed)	3.55
C	Bucket opening width	3.50

Notes:

- Buckets of 3.0m³ are for a general excavating purpose.
- Other type of bucket than above is also available.

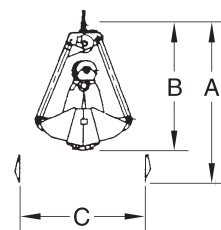

General Dimensions

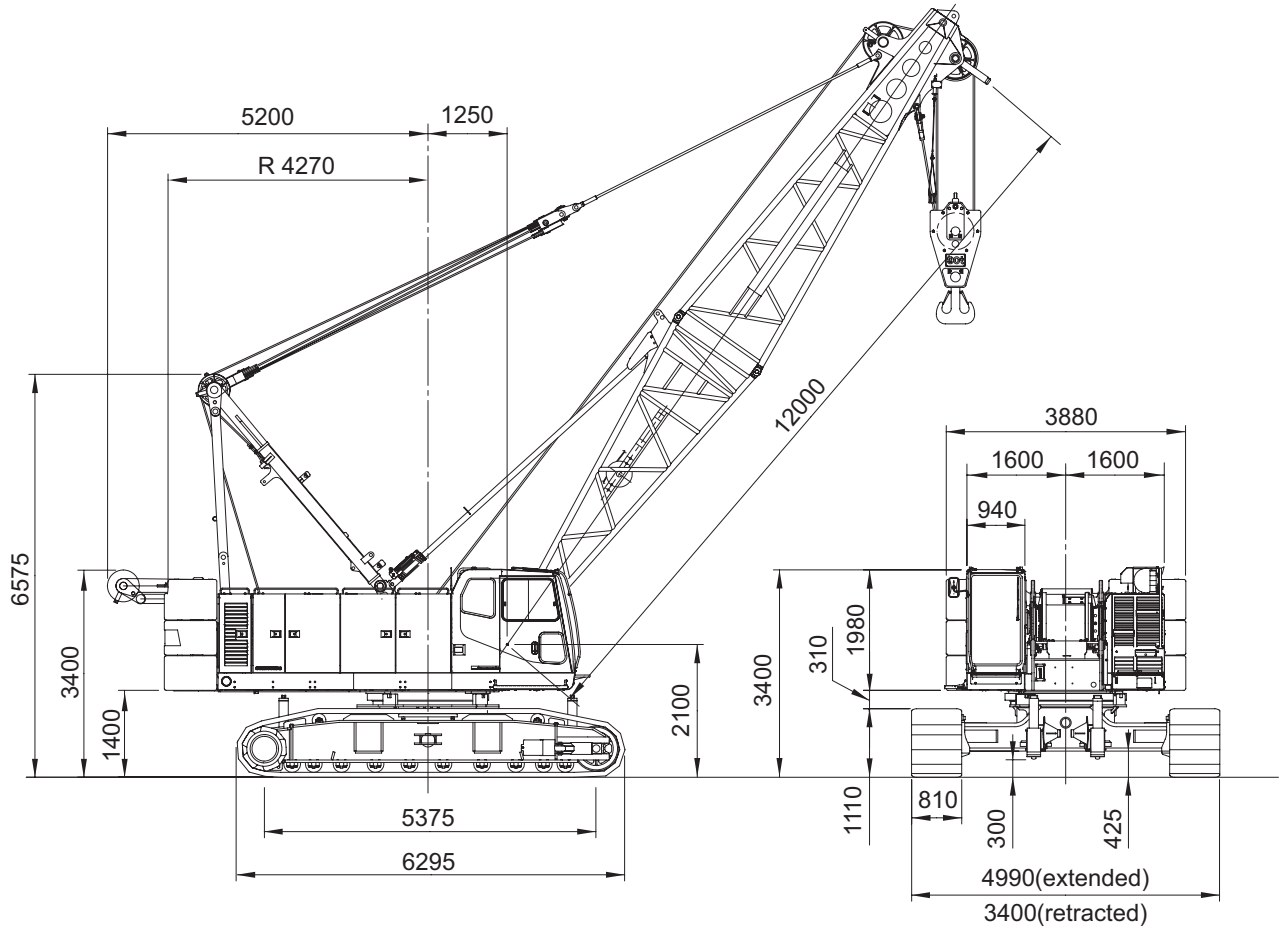









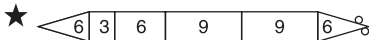
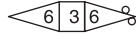
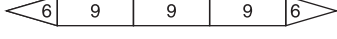
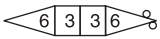
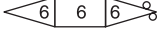

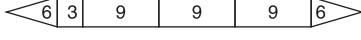
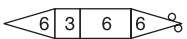
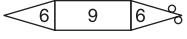
(in mm)

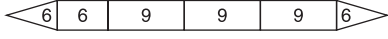
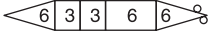
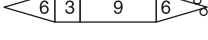
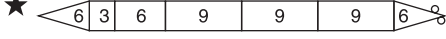
- Note:**
1. The above general arrangement is under liftcrane application with 12.0m basic boom, lower frame jack-up device and optional 90t hook block.
 2. When A-frame gantry is lowered, the dimension from center of rotation to the end of A-frame gantry is 5,200mm, and the height from G.L. to the end of the gantry is 3,400mm.

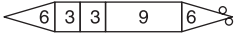
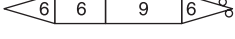
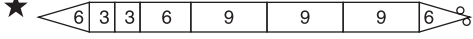
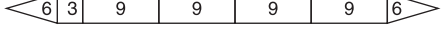
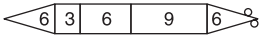
Boom Combination Diagram

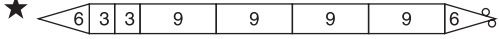
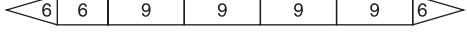
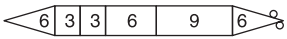
■ Crane Boom Combination

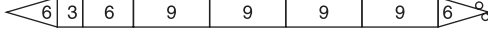
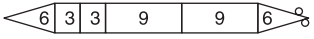
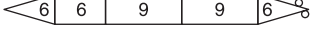
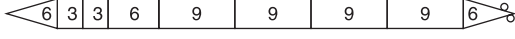
Boom Length (m)	Boom Combination	Boom Length (m)	Boom Combination
12.0		39.0	★ 
15.0			
18.0	★  	42.0	★  
21.0	★  	45.0	★  
24.0	★  	48.0	★  
27.0	★  	51.0	★  
30.0	★  	54.0	★  
33.0	★  	57.0	
36.0	★  	60.0	

Notes :

1. A star mark (★) indicates manufacturer's recommendable boom configuration. If other boom configuration is required other the above, please consult us or nearest distributor.
2. Short jib is able to attach on boom ranging from 12.0m thru 54.0m in length.
3. The meanings of figures and symbols shown above are as follows:.

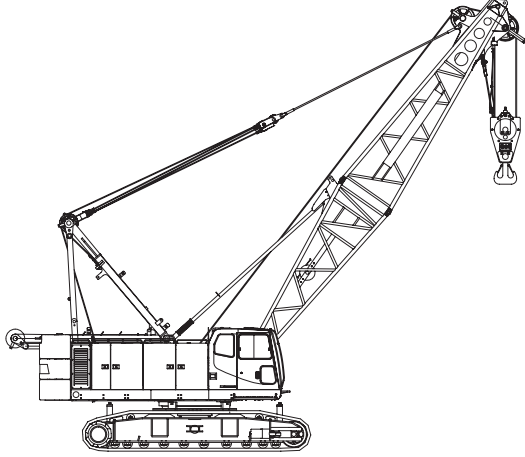
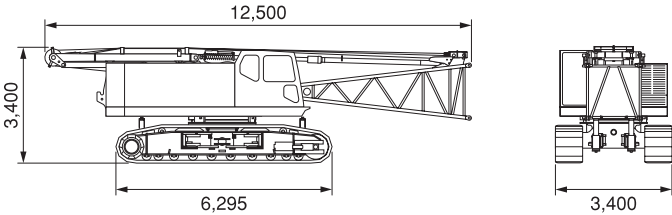
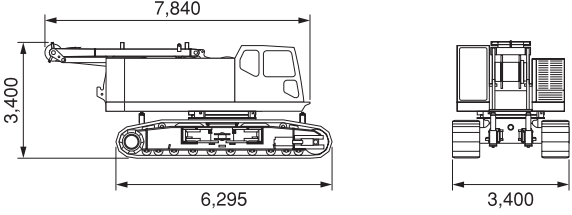
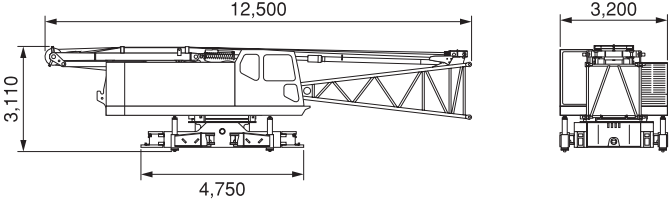
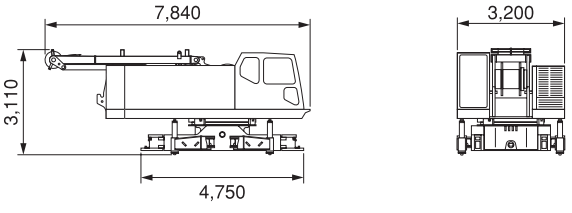

Transport Data

Description	Dimensions(mm)	Mass(kg)
<p>General Arrangement (w/liftcrane att.)</p>	 <p>(w/12.0m basic boom and 90t hook block)</p>	85,000
<p>Basic Machine with: Boom base section Front drum rope Crawler Jack-up unit (w/o Float)</p>		52,350
<p>Basic Machine with: Front drum rope Derricking rope Crawler Jack-up unit (w/o Float)</p>		50,680
<p>Superstructure with: Boom base section Front drum rope Jack-up unit (w/o Float)</p>		33,310
<p>Superstructure with: Front drum rope Jack-up unit (w/o Float)</p>		31,640

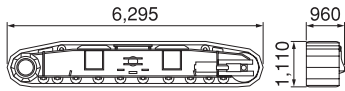
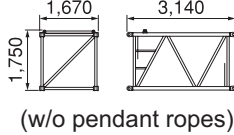
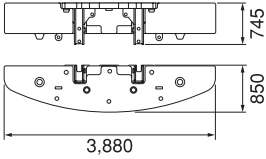
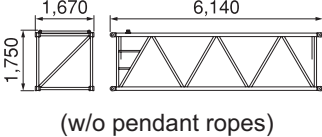
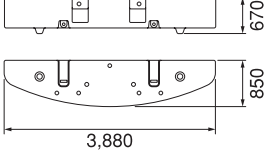
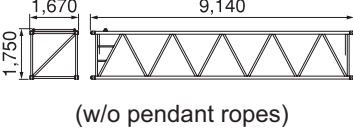
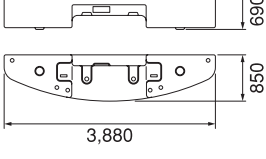
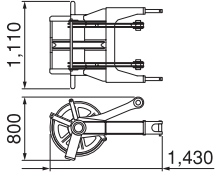
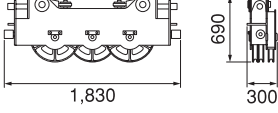
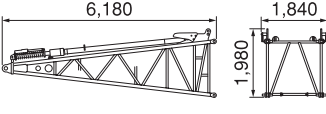
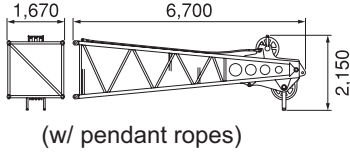
Description	Dimensions	Mass(kg)	Description	Dimensions	Mass(kg)
Crawler Side Frame		9,520 X 2	3m Boom Extension		450
Counterweight (A)		9,900	6m Boom Extension		740
Counterweight (B)		9,900	9m Boom Extension		1,060
Counterweight (C)		9,900	Short Jib		400
Bridge		380			
Boom Base Section (w/backstop)		1,670			
Boom Top Section		1,660			

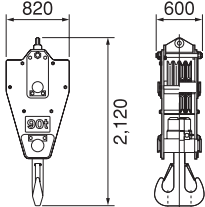
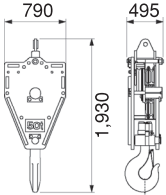
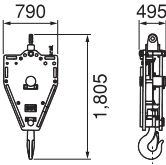
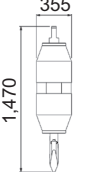
Description	Dimensions	Mass(kg)
90t Hook Block		1,200
50t Hook Block		950
35t Hook Block		730
13.5t Ball Hook Block		620

Standard and Optional Equipment

	Standard equipment	Optional equipment
Superstructure	<ul style="list-style-type: none"> • Mitsubishi 6M70-TL diesel engine with a 272kW <370ps> rated output; • Hydraulic system with three variable displacement axial piston pumps and four fixed displacement gear pumps; provided with aluminum-make oil cooler; • Control system with one each of quadruplicate and triplicate tandem valves and pilot-operated arm chair single axis control levers; provided with motorcycle type "EPC" controller (easy-precise-minute engine rpm and hyd. pump oil flow control device), and specially-tailored pressure compensating valves; • Front and rear main operating drum winches of 245kW <25t> line pull with 596mm dia. drum lagging driven by independent variable displacement hyd. motor; provided with multiple wet-disc type brake installed within drum inside together with reduction gear unit with negative brake design, brake release control under dynamic hyd. pressure, and a forced-oil cooling system. In addition, drum rotation speed controller and drum rotation sensor are also provided. Available to operate in two brake modes of automatic and free-fall; • Boom hoist mechanism driven by hyd. motor with automatic brake; provided with drum rotation speed controller and drum rotation sensor; • Slewing mechanism with turntable bearing; driven by two hyd. motor w/spring-applied, power hydraulically released multiple wet-disc brake; provided with speed control device; • Power hydraulically retractable A-frame cylinder; • 940mm wide, full-vision operator's cab with a stamped-and-rounded corner design and large front window; provided with an arrangement of armchair operator control station and instrument panel; • 29.7ton counterweight; • 2.0ton auxiliary weight; if opt. 3rd drum winch is required, this aux. weight is not furnished; • Machinery cab with hinged doors; • 24-volt electrical system with two 12-volt batteries; • Lighting system: <ul style="list-style-type: none"> • Two working lights; • Room lamp; • Rear view mirrors; • Accessories: <ul style="list-style-type: none"> • AM/FM radio w/clock; • Engine hourmeter; • Engine tachometer; indicated on display panel of LMI; • Fuel gauge; • Eng. water temp. gauge; • Engine over-heat indicator; available on display panel of LMI; • Hyd. oil over-temp. indicator; available on display panel of LMI; • Brake oil over-temp. indicator; available on display panel of LMI; • 24V electric outlet; • Dual, intermittent window shield wipers with washers; available on both front and roof windows; • Cigar lighter; • Ashtray; • Sunvisor; • Sunshade; • Cup Holder; • Non-skid surfaces; • Floor mat; • Cab front step; • Cab sidestep; • Superstructure under-cover. • Spare tools; • Spare parts. • Built-in type full air-conditioner; • Gripping bar (for cab side steps) • Centralized lubrication system (for A-frame and slewing circle) 	<ul style="list-style-type: none"> • Drum rollers; available on front/rear main drums; • Catwalks; • Third hoisting mechanism; • Re-fuel pump; • Microphone & loud-speaker; • Engine foot throttle; • Fire extinguisher; • Hyd. tagline*; (wire rope ϕ10mm$\times$$\phi$45m) • Reeving winch*; (wire rope ϕ8mm$\times$$\phi$250m) <p>Please consult us or distributor in case each single items with marked "*" are required to install simultaneously.</p>

	Standard equipment	Optional equipment
Undercarriage	<ul style="list-style-type: none"> ● 4,180mm gauge by 6,295mm long crawler lower with power hydraulically retractable/ extendible crawler side frames; ● Crawler drive units with shoe-in type traction motor with wet-disc type automatic brakes; ● 810mm wide track shoes; ● Manual track tension adjusting devices; ● Lifetime lubricated track components; ● Crawler side steps. ● Retract Unit. ● Lower frame Jack-up Unit. 	<ul style="list-style-type: none"> ● Automatic track tension adjusting device, i/o manual one as std; ● Crawler side frame lifting wire.
Liftcrane Att.	<ul style="list-style-type: none"> ● 12.0m basic boom; 6.0m base section, and 6.0m tapered top section; ● Four boom head sheaves w/two guide sheaves and rigid type cable guard; ● Bail and bridle assemblies; ● Main crane hoist cable; 28mm dia./200m long; ● Boom hoist cable; 22.4mm dia./150m long. 	<ul style="list-style-type: none"> ● 3.0m boom extension; ● 6.0m boom extension; ● 9.0m boom extension; ● Short jib; ● Short jib (2 sheaves); ● 90t duplex type hook block; ● 50t hook block; ● 35t hook block; ● 13.5t ball hook; ● Aux. crane hoist cable, 28mm dia./170m long; ● Skywalk (w/stanchion); ● Buffer. ● Boom hooking bracket
Safety Devices	<ul style="list-style-type: none"> ● Load Moment Indicator; this is a computerized automatic over-load preventing system incl. total safe operation control system; provided with a graphic display panel indicating ten and some kinds of present lifting conditions; ● Lock lever (Fool proof shut-off lever); ● Emergency engine stop switch; ● Engine start interlock system; ● Non-drum brake preventing device ● Free-fall interlocking; ● Speed slowdown device; ● Before-work check monitor ● Boom over-hoisting and -lowering limiter; ● Main hook over-hoisting limiter; ● Secondary boom over hoisting limiter; ● Slewing lock; ● Slewing alarm; ● Travel alarm; ● Independent lever locks; ● Automatic drum lock; ● Main and aux. drum pawl locks; ● Boom angle indicator; ● Level gauge; fitted on floor of operator's cab; ● Slewing brake lamp; ● Warning lamps; available for pilot line and brake system; ● Slewing brake safety circuit; ● Signal horn; ● Hook latch; ● Engine monitoring lamps; ● Travel direction arrow; ● Front-end att. erection mode; ● LMI safety circuit-off switch. ● Boom backstops; ● Lifting height indication device; ● Anemometer. 	<ul style="list-style-type: none"> ● Three color percentage indicator; ● LMI mode select switch; ● Cabin roof window guard; ● Aux. hook over-hoisting limiter; ● Open / close and suspend cable disengagement limiter; ● Drum light & mirror.

SCX900HD-2

Sumitomo Heavy Industries Construction Cranes Co., Ltd.

9-3, Higashi Ueno 6-chome, Taito-ku, Tokyo 110-0015, Japan
Phone: 81-3-3845-1387 Facsimile: 81-3-3845-1394
<http://www.hsc-cranes.com>

- We are constantly improving our products and therefore reserve the right to change designs and specifications without notice.
- Units in this specification are shown under International System of Units; the figures in parenthesis are under Gravitational System of Units as old one.

Address Inquires to: